

# DRIVENET 832 SCREW TERMINALS



CE

User's Manual rel 1.7 **GB**

D.T.S. Illuminazione srl - ITALY  
<http://www.dts-lighting.it>



Made in Italy

Le informazioni contenute in questo documento sono state attentamente redatte e controllate. Tuttavia non è assunta alcuna responsabilità per eventuali inesattezze. Tutti i diritti sono riservati e questo documento non può essere copiato, fotocopiato, riprodotto per intero o in parte senza previo consenso scritto della D.T.S .

D.T.S si riserva il diritto di apportare senza preavviso cambiamenti e modifiche estetiche , funzionali o di design a ciascun proprio prodotto. D.T.S non assume alcuna responsabilità sull'uso o sull'applicazione dei prodotti o dei circuiti descritti.

The information contained in this publication has been carefully prepared and checked. However, no responsibility will be taken for any errors. All rights are reserved and this document cannot be copied, photocopied or reproduced, in part or completely, without prior written consent from D.T.S. D.T.S. reserves the right to make any aesthetic, functional or design modifications to any of its products without prior notice. D.T.S. assumes no responsibility for the use or application of the products or circuits described herein.

Les informations contenues dans le présent manuel ont été rédigées et contrôlées avec le plus grand soin. Nous déclinons toutefois toute responsabilité en cas d'éventuelles inexactitudes. Tous droits réservés. Ce document ne peut être copié, photocopié ou reproduit, dans sa totalité ou partiellement, sans le consentement préalable de D.T.S.

D.T.S. se réserve le droit d'apporter toutes modifications et améliorations esthétiques, fonctionnelles ou de design, sans préavis, à chacun de ses produits. D.T.S. décline toute responsabilité sur l'utilisation ou sur l'application des produits ou des circuits décrits.

Las informaciones contenidas en este documento han sido cuidadosamente redactadas y controladas. Con todo, no se asume ninguna responsabilidad por eventuales inexactitudes. Todos los derechos han sido reservados y este documento no puede ser copiado, fotocopiado o reproducido, total o parcialmente, sin previa autorización escrita de D.T.S.

D.T.S. se reserva el derecho a aportar sin previo aviso cambios y modificaciones de carácter estético, funcional o de diseño a cada producto suyo. D.T.S. no se asume responsabilidad de ningún tipo sobre la utilización o sobre la aplicación de los productos o de los circuitos descritos.

## **DESCRIPTION**

### **Overview**

DRIVENET 832 is a full-range AC 90-260V 50-60Hz power supply unit dedicated specifically for use with D.T.S. Products featuring LED technology.

DRIVENET 832 features 32 output channels (4 channels x 8 groups), and can control set-ups of D.T.S. LED products in various combinations.

DRIVENET 832 is provided with a screw terminals connection panel.

DRIVENET 832 can also be remote-controlled using the USITT DMX 512 standard digital communication Protocol or by RDM.

Thanks to the "Monitoring" function it can be possible to check the status (current and voltage) of the connected units.

DRIVENET 832 is housed in a rack-mountable or sturdy metal case, that offers high resistance to mechanical stress; its body is covered with a coat of epoxy paint.

### **D.T.S. Product codes:**

03.LA.177 DRIVENET 832 Screw terminals outputs

## **TECHNICAL SPECIFICATIONS**

**Main voltage:** Full-range AC 90-260V 50-60Hz

**Output channels:** 32 (4 channels x 8 groups)

**Current:** Up to 700mA Max

**Output voltage:** 48Vdc

**Control:** DMX 512 and RDM

**DMX channels:** 32 (default), 64 ch, 10 ch, 14 ch, 80 ch, 112 ch, 48 ch and 1 ch

**Art-NET:** ETHERNET IN with RJ45 female panel connector

**Output connections:** Screw terminals

**Maximum projector distance:** 100 meters (units featuring RGBW or WHITE LEDs)  
50 meters (units featuring FC or CT LEDs)

**IP protection:** IP 20

**Working temperature:** -10° / 40°

**Rack mountable:** 2 rack units

**Display:** Touch colour graphic display

## **RDM FUNCTIONS**

DRIVENET 832 do accept the following RDM commands:

- Discovery
- Read/set DMX address
- Read/set personality
- Identify (All LEDs ON at max power)
- Producer ID
- Model description
- Software version

## **DIMENSIONS**

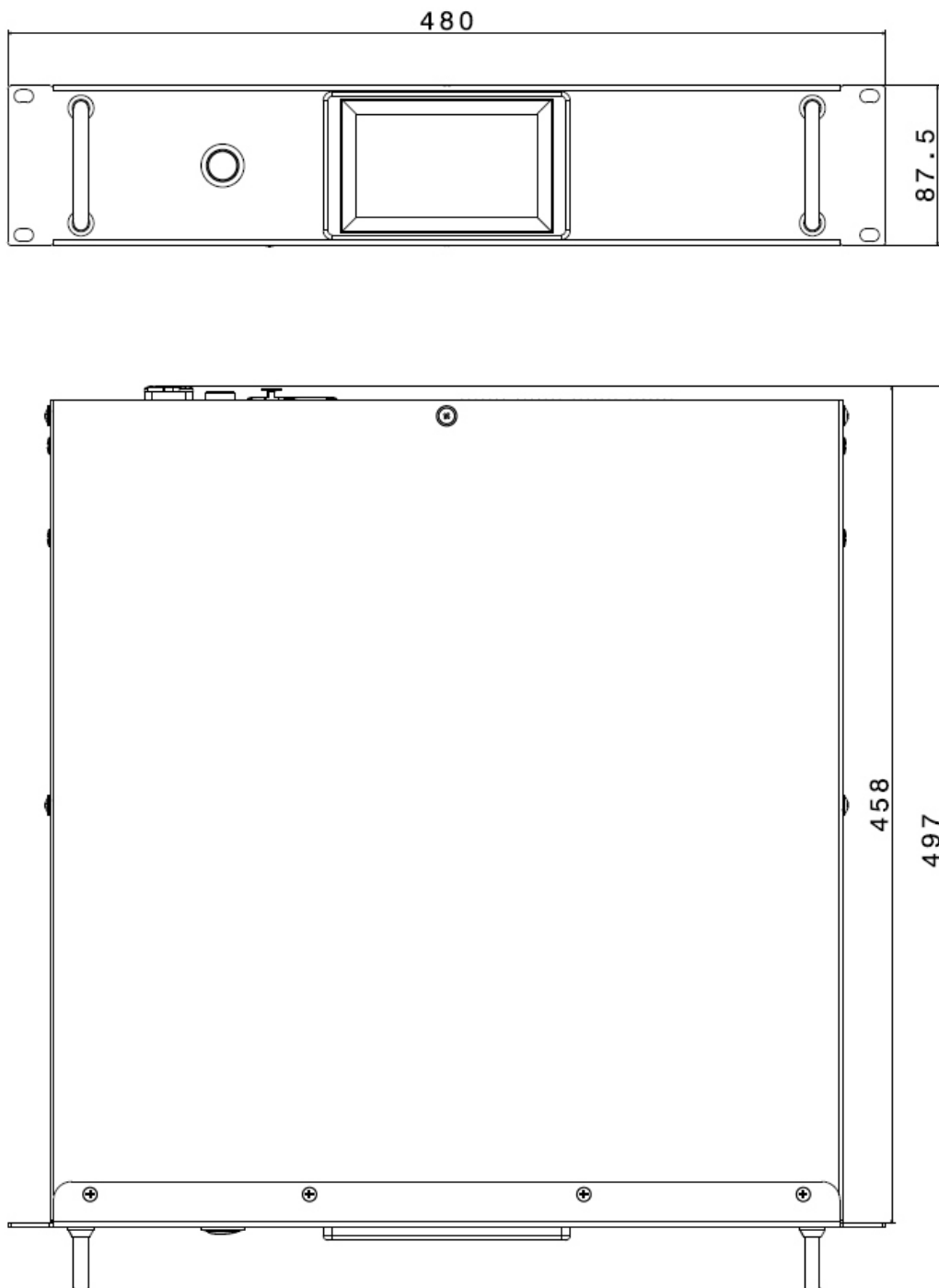

## IMPORTANT SAFETY INFORMATION

### **Fire prevention:**

It is permissible to place the unit on normally flammable surfaces.

Suitable for mounting on normally flammable materials surfaces greater than 200°C with some combustion time lag.

Replace any blown or damaged fuse only with one of identical value (15A).

### **Prevention from electric shock:**

High voltage is present inside the unit.

Unplug the unit prior to performing any operation which involves touching the inside of the unit.

This equipment must be grounded, do not connect to non-grounded supplies.

The use of a thermal magnetic circuit breaker is recommended for each DRIVENET 832.

Use only AC supplies 90-260V 50-60Hz.

The unit should never be located in position exposed to rain or in areas of extreme humidity.

A good air ventilation is essential for proper equipment work.

### **Safety:**

The external surface of the unit may exceed 50°C; never handle the unit until at least 5 minutes have elapsed since the unit was turned off.

Never install the unit in an enclosed area lacking sufficient air flow.

The ambient temperature should not exceed 40°C and should not be lower than -10°C.

## CONNECTION PANEL

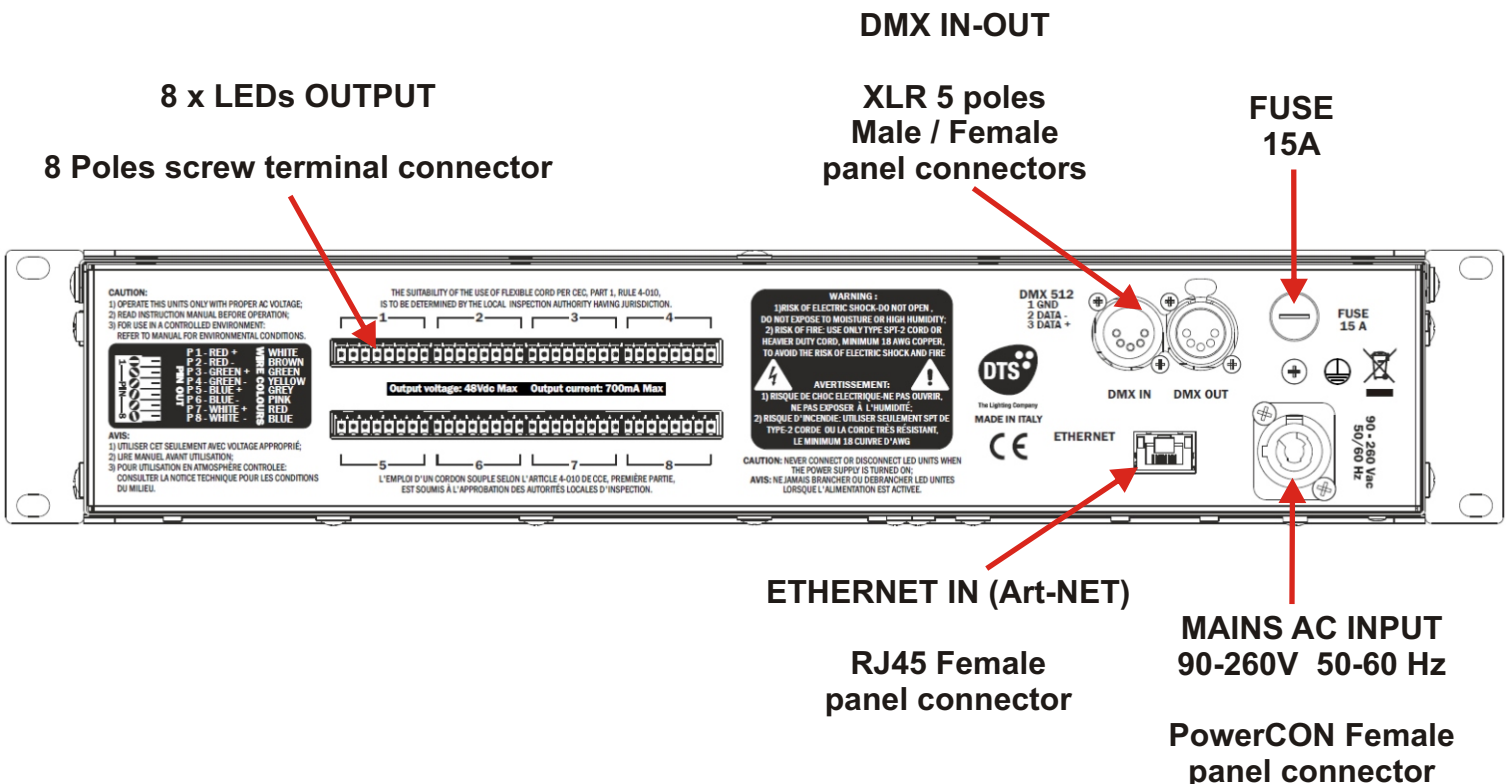

The maximum distance between DRIVENET 832 and unit featuring RGBW or WHITE LEDs should not exceed 100 meters.

The maximum distance between DRIVENET 832 and unit featuring FC or CT LEDs should not exceed 50 meters.

## DMX SIGNAL CONNECTION:

The unit operates using a digital DMX 512 signal. Connection between the controller and the unit or between units must be carried out using a two pair screened  $\varnothing$  0.5 mm cable and a CANNON XLR 5 pins connector.

Ensure that the conductors do not touch each other. Do not connect the cable ground to the XLR chassis. The plug housing must be isolated. Connect the mixer signal to the DMX IN of the Z8 plug and connect it to the next unit by connecting the DMX OUT plug on the first Z8 to the DMX IN plug of the second one.

This way, all the projectors are cascade connected.

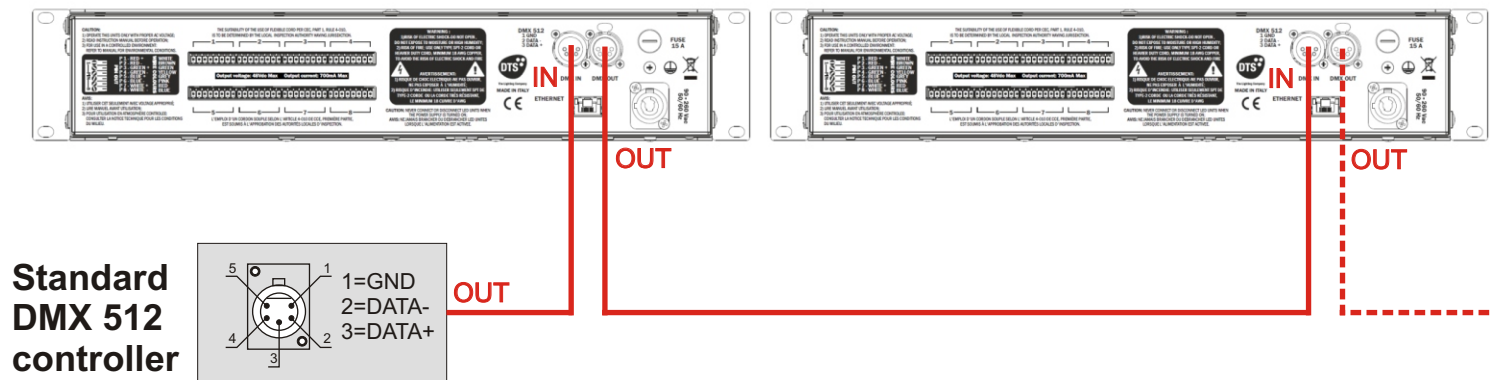

P.S: If the display showing the DMX address flashes, then one of the following errors has occurred:

- DMX signal not present
- DMX reception problem

For Installations where long distance DMX cable connections are needed, we suggest to use a DMX terminator.

The DMX terminator is a male XLR 3-5 pins connector with a 120 ohm resistor Between pin 2 and 3. The DMX terminator must be plugged into the last unit (DMX out panel connector) of the DMX line.

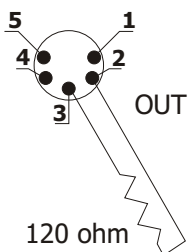

PLACE A 120 OHM RESISTOR BETWEEN PIN 2 AND 3 OF A MALE XLR CONNECTOR AND PLUG IT INTO THE DMX OUT PANEL CONNECTOR OF THE LAST UNIT CONNECTED TO THE DMX LINE

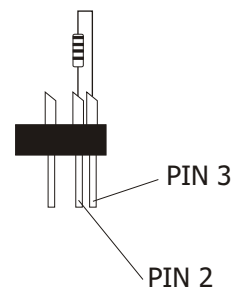

## DMX ADDRESS

DRIVENET 832 can be used in 8 DMX modes: 32 ch (default), 64 ch, 10 ch, 14 ch, 112 ch, 80 ch, 48 ch or 1 ch mode.

If you want to use the DRIVENET 832 in 32 channels mode, select the "**Full type - 8 bit**" mode from the DMX MODE menu under DMX SETUP and set the following addresses on the mixer:

Projector 1	A001	
Projector 2	A033	If you want to select the next projector, just add "32"
Projector 3	A065	
.....	A....	
projector 6	A161	

If you want to use the DRIVENET 832 in 10 channels mode, select the "**Z1 type - 8 bit**" mode from the DMX MODE menu under DMX SETUP and set the following addresses on the mixer:

Projector 1	A001	
Projector 2	A011	If you want to select the next projector, just add "10"
Projector 3	A021	
.....	A....	
projector 6	A051	

### Selecting the DMX address

- 1) Press the UP-DOWN key until you reach the required DMX address. The numbers on the display will start flashing (but the new DMX address hasn't yet been set).
- 2) Press ENTER to confirm your selection. The numbers on the display will stop flashing and the projector is now controlled by the new DMX address.

TIPS: if you keep pushed the UP or DOWN keys, the channels are calculated more quickly and you get a faster selection.

## DISPLAY FUNCTIONS

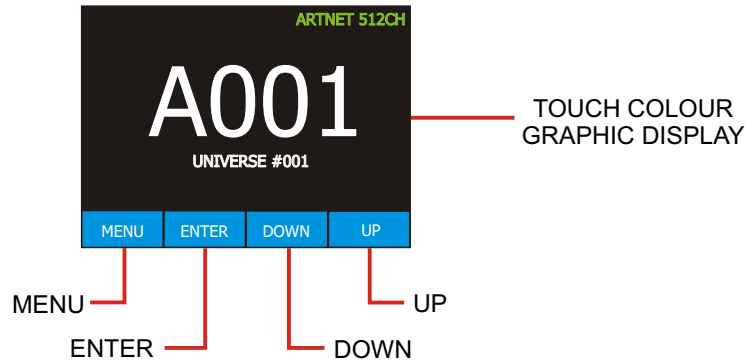

## DISPLAY FUNCTIONS

The DRIVENET 832 display panel shows all the available functions.

Using these functions, it is possible to change some of the parameters and add some functions.

Changing the D.T.S. setting can vary the functions of the unit so that it does not respond to the DMX 512 signal used to control it.

Carefully follow the instructions below before carrying out any variations or selections.

NOTE: the symbol  shows which key has to be pushed to obtain the desired function.

### Software version 1.13



Menu



Up-Down

Display



ENTER



Up-Down

#### DISPLAY POSITION

Reverses display's reading depending on the mounting position

(on the ground or suspended).

#### DISPLAY STANDBY

To turn off the display (after 30 seconds) or leave it always on.

#### TOUCH SCREEN CALIBRATION

To calibrate the touch screen.

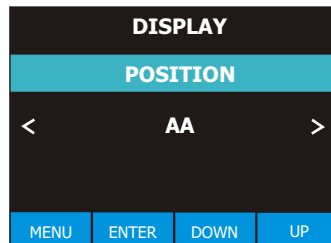

#### DISPLAY POSITION

ON THE GROUND (Default)  
SUSPENDED



ENTER

#### DISPLAY STANDBY

OFF = Display standby disabled (default)  
ON = Display goes off after 30 seconds



ENTER

#### TOUCH SCREEN CALIBRATION

To calibrate the touch screen



ENTER





## DMX Setup



## DMX MODE

To select DMX mode:

Full Type 8 bit 32 DMX ch.

Full Type 16 bit 64 DMX ch.

Z1 Type 8 bit 10 DMX ch.

Z1 Type 16 bit 14 DMX ch (for Chase and Cue recording).

Z1 Full 8 bit 10x8 = 80 DMX ch.

Z1 Full 16 bit 14x8 = 112 DMX ch.

Z1 Short Full 8 bit 6x8 = 48 DMX ch.

Z1 Short Full 16 bit 10x8 = 80 DMX ch.

1 CH Full = 1 DMX channel

MACRO mode: Standard or Extended

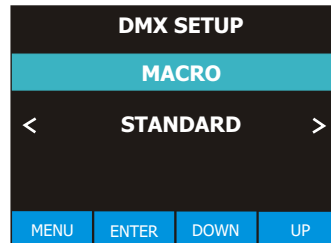
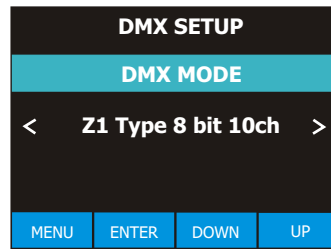

## DMX MODE MAP

**Full type - 8 bit** = 32 DMX ch (default)  
= RGBW 4 ch each output: 1-Red, 2-Green, 3-Blue, 4-White.

**Full type - 16 bit** = 64 DMX ch mode  
= RGBW 2ch each colour; 8ch each output:  
1-Red 8 bit, 2-Red 16 bit, 3-Green 8 bit,  
4-Green 16 bit, 5-Blue 8 bit, 6-Blue 16 bit,  
7-White 8 bit, 8-White 16 bit

**Z1 type - 8 bit** = 10 DMX ch mode with all the outputs automatically set on DMX starting channel 1:

1=Shutter, 2=Dimmer, 3=Red, 4=Green,  
5=Blue, 6=White, 7=White control, 8=CTC,  
9=Macro, 10=Function

**Z1 type - 16 bit** = 14 DMX ch mode with Dimmer and RGBW channels with 16 bit control and all outputs automatically set on DMX starting address 1:

1=Shutter, 2=Dimmer, 3=Red 8 bit, 4=Red 16 bit, 5=Green 8 bit, 6=Green 16 bit, 7=Blue 8 bit, 8=Blue 16 bit, 9=White 8 bit, 10=White 16 bit, 11=White control, 12=CTC, 13=Macro, 14=Function

**Z1 full - 8 bit** = (10x8) 80 DMX ch mode same as Z1 type 8 bit 10ch but each output with independent DMX control:

Output 1=DMX 1, Output 2= DMX 11, Output 3= DMX 21 ...

**Z1 full - 16 bit** = (14x8) 112 DMX ch mode same as Z1 type 16 bit 14ch but each output with independent DMX control:

Output 1 = DMX 1, Output 2 = DMX 15, Output 3 = DMX 29...

**Z1 short full - 8 bit** = (6x8) 48 DMX ch. mode with Dimmer, Shutter and RGBW 8 bit channels and each output with independent DMX control

Output 1 = DMX 1, Output 2 = DMX 7, Output 3 = DMX 13...

**Z1 short full - 16 bit** = (10x8) 80 DMX ch. mode with RGBW 16 bit each colour and each output with independent DMX control

Output 1 = DMX 1, Output 2 = DMX 11, Output 3 = DMX 21...  
1-Dimmer, 2-Shutter, 3-Red 8 bit, 4-Red 16 bit, 5-Green 8 bit, 6-Green 16 bit, 7-Blue 8 bit, 8-Blue 16 bit, 9-White 8 bit, 10-White 16 bit

**1 CH full** = 1 DMX channel

## MACRO

**STANDARD** = Standard mode enabled (default)

**EXTENDED** = Enable rainbow effects on Macro channel





LED



RGBA MINIMUM VALUES

This menu allows to select the minimum levels for Red/White1, Green/White2, Blue/White3 and White/White4.

RGBA MAXIMUM VALUES

This menu allows to select the maximum levels for Red/White1, Green/White2, Blue/White3 and White/White4. These settings have priority on Master Dimmer channel.

SMOOTH VALUE

This menu allows to select the value of the delay (in milliseconds) for RGBA and Dimmer channels reaction to DMX or program variation.  
 4 = 25 ms delay (Fast response)  
 20 = 250 ms delay (Slow response)

GAMMA CORRECTION

This menu allows to select between Linear current output or Quadratic current output for LEDs  
 Default = Quadratic

OUTPUT FREQUENCY

This menu allows to adjust the PWM frequency value (Hz) in order to reduce flickering in the process of your camera Recordings

LED BOOST

With Boost ON, the LED's current has the same value pre-set into the "LED CURRENTS" menu (see below).  
 With Boost OFF the medium current of each output channel is approximately 30% less (through PWM modulation) of the maximum current pre-set into the "LED CURRENTS" menu.

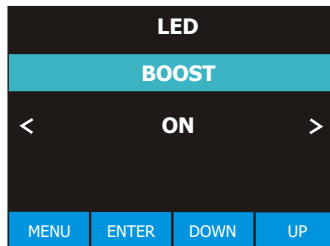
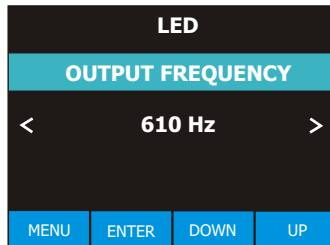
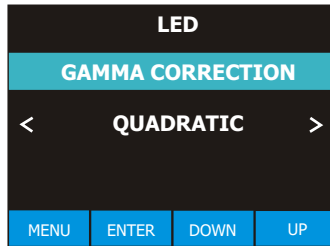
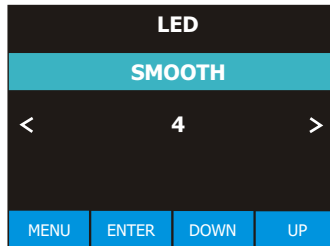
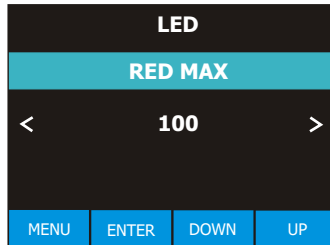
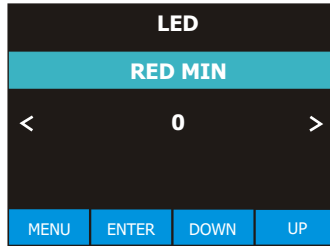

RED Min default = 0  
 RED Max default = 100

GREEN Min default = 0  
 GREEN Max default = 100

BLUE Min default = 0  
 BLUE Max default = 100

AMBER Min default = 0  
 AMBER Max default = 100

SMOOTH  
 Range = Off - 20  
 Default = 4

GAMMA CORRECTION  
 Linear = Linear current output  
 Quadratic = Linear light output (default)

OUTPUT FREQUENCY  
 Range = 610 Hz - 20 KHz  
 Default = 610 Hz

LED BOOST  
 ON-OFF  
 Default = OFF



LED CURRENTS



ALL OUTPUT CHANNELS CURRENT SELECTION

This menu allows to select the same maximum LED current (peak) for all output channels.

OUTPUT CHANNEL CURRENT SELECTION

This menu allows to select the maximum LED current (peak) independently for each output channel.

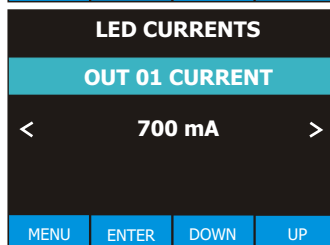
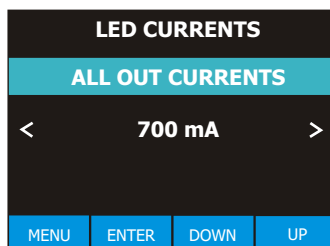

LED CURRENTS  
 Range = 200 mA - 700 mA (50mA by 50mA selectable steps)  
 Default = 700 mA





**AUTO**



**AUTOMATIC MODE**

Automatic demo game without DMX controller

**STEP 01/16**

Chase with 16 steps previously created in REC MODE

Speed time, Wait time and Dimmer values selectable by user.

**PERSONAL COLOURS**

RGBA, Dimmer and Shutter values selectable by user.

**RAINBOW**

Rainbow colours effect.

Speed time, Dimmer and Shutter values Selectable by user.

**FIXED COLOURS**

Sixteen colour macros as on "MACRO" channel.

Dimmer and Shutter values selectable by user.

**WHITE MACROS**

Sixteen macros for White colour.

Dimmer and Shutter values selectable by user.

**AUTO**

**SURE?**

< MENU: NO - ENTER: YES >

MENU
ENTER
DOWN
UP

---

**AUTO-PROGRAM**

**STEP**

< 01/16 >

MENU
ENTER
DOWN
UP

---

**AUTO-PERS.COLORS**

**RED**

< 120 >

MENU
ENTER
DOWN
UP

---

**AUTO-RAINBOW**

**SPEED**

< 0006 >

MENU
ENTER
DOWN
UP

---

**AUTO-FIXED COLORS**

**COLOR**

< 9 >

MENU
ENTER
DOWN
UP

---

**AUTO-WHITE**

**WHITE**

< 1 >

MENU
ENTER
DOWN
UP

By setting all the units connected to the MASTER to DMX address 1, they will be synchronized with the Master unit following the chase selected on it, including Time and Wait of the Master unit.





EMERGENCY



EMERGENCY OPERATING MODE.  
By setting this mode, it will be possible to select one of the 16 pre-programmed White cues that will then run if DMX signal is missing or not available. Useful for emergency exit illumination on public areas.  
Dimmer level selectable by user.

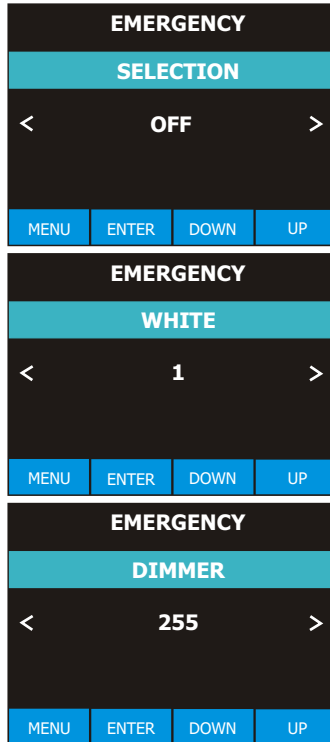

EMERGENCY  
Disable = Default



WHITE (1-16)  
Default = WHITE 1

DIMMER  
Default = 255



DEFAULT SET



DEFAULT SETTINGS  
To restore factory settings

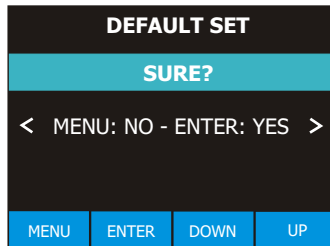

TEMPERATURES



TEMPERATURES MONITORING  
Display board and LED Driver boards temperature

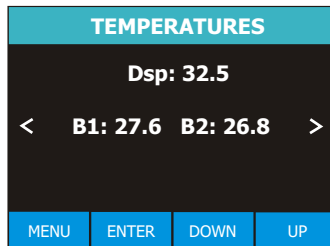

MEASURES



STATUS OF THE CONNECTED UNITS  
This menu allows to check the status (current and voltage) of the connected units.

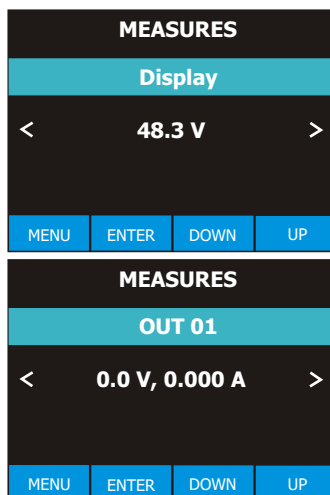



TIME



This menu shows the total UNIT life time and the RGBA life time

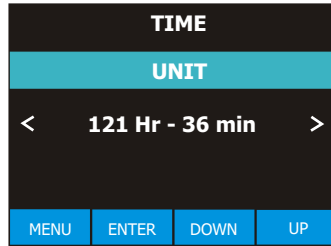

NETWORK



**Art-NET COMMUNICATION PROTOCOL**  
This menu allows to enable/disable the Art-NET communication protocol. With Art-NET enabled the Art-NET signal has the priority on the DMX signal.

**Art-NET DMX UNIVERSE**  
This menu allows to set the DMX universe.

**NETWORK SETTINGS**  
This menu allows to choose the mode to set the network parameters (IP address, Subnet mask, Gateway, DNS):  
USE DHCP = automatic setting of the network parameters through a DHCP server on the local area network.  
FIXED = Fixed setting of the network parameters.  
CUSTOM = Manual setting of the network parameters.

**IP ADDRESS**  
This menu shows the IP address of the DRIVENET. You can set up all bytes of the IP address only if NETWORK SETTINGS = CUSTOM.

**SUBNET MASK**  
This menu shows the subnet mask. You can set up all bytes of the subnet mask only if NETWORK SETTINGS = CUSTOM.

**GATEWAY**  
This menu shows the gateway. You can set up all bytes of the gateway only if NETWORK SETTINGS = CUSTOM.

**DNS**  
This menu shows the domain name server. You can set up all bytes of the DNS only if NETWORK SETTINGS = CUSTOM.

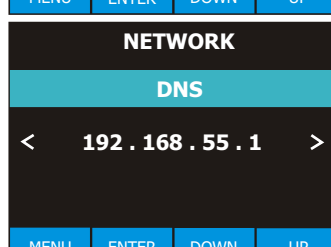
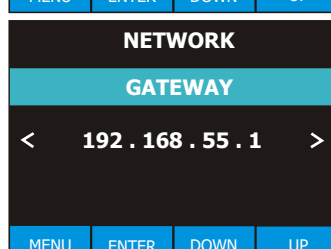
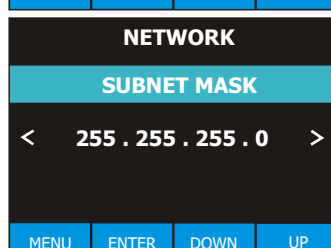
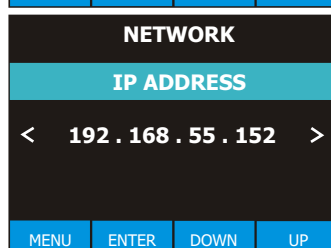
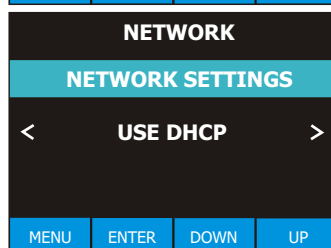
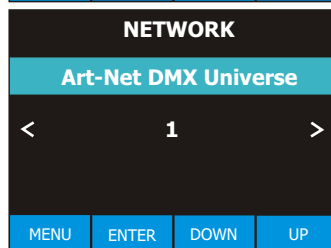
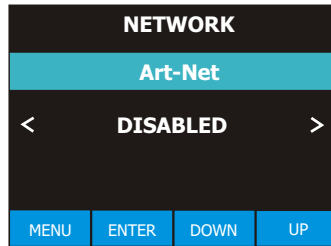

Art-NET ENABLED or DISABLED  
Default = DISABLED



Art-NET DMX Universe  
Range: 0 - 255  
Default = 0

NETWORK SETTINGS: USE DHCP, FIXED or CUSTOM  
Default = USE DHCP

IP ADDRESS  
IP address displaying

SUBNET MASK  
Subnet mask displaying

GATEWAY  
Gateway displaying

DNS  
Domain name server displaying



SYSTEM



**FAN MAX SPEED**  
This menu allows to select the internal fans speed

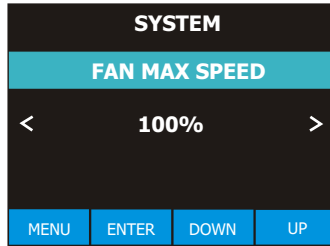

**FAN MAX SPEED**  
50% - 100%  
Default = 100%



SOFTWARE



**SOFTWARE**  
Display board and LED Driver boards software version

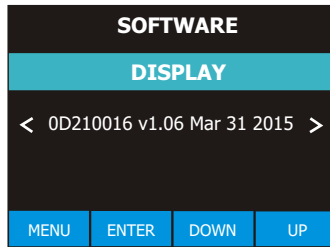

Display board software version

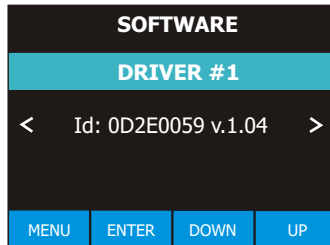

LED Driver board 1 software version

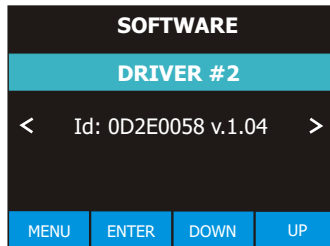

LED Driver board 2 software version

**DMX PROTOCOL****“FULL TYPE - 8 BIT” 32 DMX Channels (Default)**

<b>1</b>	<b>RED</b>	<b>1</b>	<b>17</b>	<b>RED</b>	<b>5</b>
<b>2</b>	<b>GREEN</b>	<b>1</b>	<b>18</b>	<b>GREEN</b>	<b>5</b>
<b>3</b>	<b>BLUE</b>	<b>1</b>	<b>19</b>	<b>BLUE</b>	<b>5</b>
<b>4</b>	<b>WHITE</b>	<b>1</b>	<b>20</b>	<b>WHITE</b>	<b>5</b>
<b>5</b>	<b>RED</b>	<b>2</b>	<b>21</b>	<b>RED</b>	<b>6</b>
<b>6</b>	<b>GREEN</b>	<b>2</b>	<b>22</b>	<b>GREEN</b>	<b>6</b>
<b>7</b>	<b>BLUE</b>	<b>2</b>	<b>23</b>	<b>BLUE</b>	<b>6</b>
<b>8</b>	<b>WHITE</b>	<b>2</b>	<b>24</b>	<b>WHITE</b>	<b>6</b>
<b>9</b>	<b>RED</b>	<b>3</b>	<b>25</b>	<b>RED</b>	<b>7</b>
<b>10</b>	<b>GREEN</b>	<b>3</b>	<b>26</b>	<b>GREEN</b>	<b>7</b>
<b>11</b>	<b>BLUE</b>	<b>3</b>	<b>27</b>	<b>BLUE</b>	<b>7</b>
<b>12</b>	<b>WHITE</b>	<b>3</b>	<b>28</b>	<b>WHITE</b>	<b>7</b>
<b>13</b>	<b>RED</b>	<b>4</b>	<b>29</b>	<b>RED</b>	<b>8</b>
<b>14</b>	<b>GREEN</b>	<b>4</b>	<b>30</b>	<b>GREEN</b>	<b>8</b>
<b>15</b>	<b>BLUE</b>	<b>4</b>	<b>31</b>	<b>BLUE</b>	<b>8</b>
<b>16</b>	<b>WHITE</b>	<b>4</b>	<b>32</b>	<b>WHITE</b>	<b>8</b>

DMX CHANNEL	<b>1</b>	Parameter: <b>RED 1</b>
-------------	----------	-------------------------

DMX range Value	Mid point DMX value	Move range (degrees)	Mode	Option	Function
<b>000-255</b>					<b>Proportional colour</b>

DMX CHANNEL	<b>2</b>	Parameter: <b>GREEN1</b>
-------------	----------	--------------------------

DMX range Value	Mid point DMX value	Move range (degrees)	Mode	Option	Function
<b>000-255</b>					<b>Proportional colour</b>

DMX CHANNEL	<b>3</b>	Parameter: <b>BLUE 1</b>
-------------	----------	--------------------------

DMX range Value	Mid point DMX value	Move range (degrees)	Mode	Option	Function
<b>000-255</b>					<b>Proportional colour</b>

DMX CHANNEL	<b>4</b>	Parameter: <b>WHITE 1</b>
-------------	----------	---------------------------

DMX range Value	Mid point DMX value	Move range (degrees)	Mode	Option	Function
<b>000-255</b>					<b>Proportional colour</b>

DMX CHANNEL	<b>5</b>	Parameter: <b>RED 2</b>			
-------------	----------	-------------------------	--	--	--

DMX range Value	Mid point DMX value	Move range (degrees)	Mode	Option	Function
<b>000-255</b>					<b>Proportional colour</b>

DMX CHANNEL	<b>6</b>	Parameter: <b>GREEN 2</b>			
-------------	----------	---------------------------	--	--	--

DMX range Value	Mid point DMX value	Move range (degrees)	Mode	Option	Function
<b>000-255</b>					<b>Proportional colour</b>

DMX CHANNEL	<b>7</b>	Parameter: <b>BLUE 2</b>			
-------------	----------	--------------------------	--	--	--

DMX range Value	Mid point DMX value	Move range (degrees)	Mode	Option	Function
<b>000-255</b>					<b>Proportional colour</b>

DMX CHANNEL	<b>8</b>	Parameter: <b>WHITE 2</b>			
-------------	----------	---------------------------	--	--	--

DMX range Value	Mid point DMX value	Move range (degrees)	Mode	Option	Function
<b>000-255</b>					<b>Proportional colour</b>

DMX CHANNEL	<b>9</b>	Parameter: <b>RED 3</b>			
-------------	----------	-------------------------	--	--	--

DMX range Value	Mid point DMX value	Move range (degrees)	Mode	Option	Function
<b>000-255</b>					<b>Proportional colour</b>

DMX CHANNEL	<b>10</b>	Parameter: <b>GREEN 3</b>			
-------------	-----------	---------------------------	--	--	--

DMX range Value	Mid point DMX value	Move range (degrees)	Mode	Option	Function
<b>000-255</b>					<b>Proportional colour</b>

DMX CHANNEL	<b>11</b>	Parameter: <b>BLUE 3</b>			
-------------	-----------	--------------------------	--	--	--

DMX range Value	Mid point DMX value	Move range (degrees)	Mode	Option	Function
<b>000-255</b>					<b>Proportional colour</b>

DMX CHANNEL	<b>12</b>	Parameter: <b>WHITE 3</b>			
-------------	-----------	---------------------------	--	--	--

DMX range Value	Mid point DMX value	Move range (degrees)	Mode	Option	Function
<b>000-255</b>					<b>Proportional colour</b>



DMX CHANNEL	13	Parameter: <b>RED 4</b>			
-------------	----	-------------------------	--	--	--

DMX range Value	Mid point DMX value	Move range (degrees)	Mode	Option	Function
<b>000-255</b>					<b>Proportional colour</b>

DMX CHANNEL	14	Parameter: <b>GREEN 4</b>			
-------------	----	---------------------------	--	--	--

DMX range Value	Mid point DMX value	Move range (degrees)	Mode	Option	Function
<b>000-255</b>					<b>Proportional colour</b>

DMX CHANNEL	15	Parameter: <b>BLUE 4</b>			
-------------	----	--------------------------	--	--	--

DMX range Value	Mid point DMX value	Move range (degrees)	Mode	Option	Function
<b>000-255</b>					<b>Proportional colour</b>

DMX CHANNEL	16	Parameter: <b>WHITE 4</b>			
-------------	----	---------------------------	--	--	--

DMX range Value	Mid point DMX value	Move range (degrees)	Mode	Option	Function
<b>000-255</b>					<b>Proportional colour</b>

DMX CHANNEL	17	Parameter: <b>RED 5</b>			
-------------	----	-------------------------	--	--	--

DMX range Value	Mid point DMX value	Move range (degrees)	Mode	Option	Function
<b>000-255</b>					<b>Proportional colour</b>

DMX CHANNEL	18	Parameter: <b>GREEN 5</b>			
-------------	----	---------------------------	--	--	--

DMX range Value	Mid point DMX value	Move range (degrees)	Mode	Option	Function
<b>000-255</b>					<b>Proportional colour</b>

DMX CHANNEL	19	Parameter: <b>BLUE 5</b>			
-------------	----	--------------------------	--	--	--

DMX range Value	Mid point DMX value	Move range (degrees)	Mode	Option	Function
<b>000-255</b>					<b>Proportional colour</b>

DMX CHANNEL	20	Parameter: <b>WHITE 5</b>			
-------------	----	---------------------------	--	--	--

DMX range Value	Mid point DMX value	Move range (degrees)	Mode	Option	Function
<b>000-255</b>					<b>Proportional colour</b>

DMX CHANNEL	21	Parameter: <b>RED 6</b>			
-------------	----	-------------------------	--	--	--

DMX range Value	Mid point DMX value	Move range (degrees)	Mode	Option	Function
<b>000-255</b>					<b>Proportional colour</b>

DMX CHANNEL	22	Parameter: <b>GREEN 6</b>			
-------------	----	---------------------------	--	--	--

DMX range Value	Mid point DMX value	Move range (degrees)	Mode	Option	Function
<b>000-255</b>					<b>Proportional colour</b>

DMX CHANNEL	23	Parameter: <b>BLUE 6</b>			
-------------	----	--------------------------	--	--	--

DMX range Value	Mid point DMX value	Move range (degrees)	Mode	Option	Function
<b>000-255</b>					<b>Proportional colour</b>

DMX CHANNEL	24	Parameter: <b>WHITE 6</b>			
-------------	----	---------------------------	--	--	--

DMX range Value	Mid point DMX value	Move range (degrees)	Mode	Option	Function
<b>000-255</b>					<b>Proportional colour</b>

DMX CHANNEL	25	Parameter: <b>RED 7</b>			
-------------	----	-------------------------	--	--	--

DMX range Value	Mid point DMX value	Move range (degrees)	Mode	Option	Function
<b>000-255</b>					<b>Proportional colour</b>

DMX CHANNEL	26	Parameter: <b>GREEN 7</b>			
-------------	----	---------------------------	--	--	--

DMX range Value	Mid point DMX value	Move range (degrees)	Mode	Option	Function
<b>000-255</b>					<b>Proportional colour</b>

DMX CHANNEL	27	Parameter: <b>BLUE 7</b>			
-------------	----	--------------------------	--	--	--

DMX range Value	Mid point DMX value	Move range (degrees)	Mode	Option	Function
<b>000-255</b>					<b>Proportional colour</b>

DMX CHANNEL	28	Parameter: <b>WHITE 7</b>			
-------------	----	---------------------------	--	--	--

DMX range Value	Mid point DMX value	Move range (degrees)	Mode	Option	Function
<b>000-255</b>					<b>Proportional colour</b>

DMX CHANNEL	29	Parameter: <b>RED 8</b>			
-------------	----	-------------------------	--	--	--

DMX range Value	Mid point DMX value	Move range (degrees)	Mode	Option	Function
<b>000-255</b>					<b>Proportional colour</b>

DMX CHANNEL	30	Parameter: <b>GREEN 8</b>			
-------------	----	---------------------------	--	--	--

DMX range Value	Mid point DMX value	Move range (degrees)	Mode	Option	Function
<b>000-255</b>					<b>Proportional colour</b>

DMX CHANNEL	31	Parameter: <b>BLUE 8</b>			
-------------	----	--------------------------	--	--	--

DMX range Value	Mid point DMX value	Move range (degrees)	Mode	Option	Function
<b>000-255</b>					<b>Proportional colour</b>

DMX CHANNEL	32	Parameter: <b>WHITE 8</b>			
-------------	----	---------------------------	--	--	--

DMX range Value	Mid point DMX value	Move range (degrees)	Mode	Option	Function
<b>000-255</b>					<b>Proportional colour</b>

**DMX PROTOCOL****"Z1 TYPE - 8 BIT" 10 DMX Channels**

- 1 SHUTTER**
- 2 DIMMER**
- 3 RED**
- 4 GREEN**
- 5 BLUE**
- 6 WHITE**
- 7 WHITE PRE-PROGRAMMED (Whites at different colour temperatures)**
- 8 CTC**
- 9 MACRO**
- 10 FUNCTIONS**

DMX CHANNEL	<b>1</b>	Parameter: <b>SHUTTER</b>
-------------	----------	---------------------------

DMX range Value	Mid point DMX value	Move range (degrees)	Mode	Option	Function
<b>0-9</b>	<b>5</b>				<b>Black-out</b>
<b>10-19</b>	<b>14</b>				<b>Open</b>
<b>20-29</b>	<b>24</b>				<b>Black-out</b>
<b>30-119</b>					<b>Strobe at variable speed from slow to fast (3,27 s - 30 ms)</b>
<b>120-149</b>					<b>Pulse open at variable speed from slow to fast (42,6 s - 120 ms)</b>
<b>150-179</b>					<b>Pulse close at variable speed from slow to fast (42,6 s - 120 ms)</b>
<b>180-204</b>	<b>192</b>				<b>Random Strobe (Master and RGBW active)</b>
<b>205-229</b>	<b>218</b>				<b>Random Strobe (Full)</b>
<b>230-255</b>	<b>240</b>				<b>Open</b>

DMX CHANNEL	<b>2</b>	Parameter: <b>DIMMER</b>
-------------	----------	--------------------------

DMX range Value	Mid point DMX value	Move range (degrees)	Mode	Option	Function
<b>0-255</b>					<b>Proportional dimmer</b>

DMX CHANNEL	<b>3</b>	Parameter: <b>RED</b>
-------------	----------	-----------------------

DMX range Value	Mid point DMX value	Move range (degrees)	Mode	Option	Function
<b>0-255</b>					<b>Proportional colour</b>

DMX CHANNEL	4	Parameter: <b>GREEN</b>
-------------	---	-------------------------

DMX range Value	Mid point DMX value	Move range (degrees)	Mode	Option	Function
<b>0-255</b>					<b>Proportional colour</b>

DMX CHANNEL	5	Parameter: <b>BLUE</b>
-------------	---	------------------------

DMX range Value	Mid point DMX value	Move range (degrees)	Mode	Option	Function
<b>0-255</b>					<b>Proportional colour</b>

DMX CHANNEL	6	Parameter: <b>WHITE</b>
-------------	---	-------------------------

DMX range Value	Mid point DMX value	Move range (degrees)	Mode	Option	Function
<b>0-255</b>					<b>Proportional colour</b>

DMX CHANNEL	7	Parameter: <b>WHITE PRE-PROGRAMMED</b> (Whites at diff. color temperature)
-------------	---	--

DMX range Value	Mid point DMX value	Move range (degrees)	Mode	Option	Function
<b>0-55</b>	<b>23</b>				<b>No Function</b>
<b>56-105</b>	<b>80</b>				<b>Full (Red-Green-Blue at Full)</b>
<b>106-155</b>	<b>130</b>				<b>White DTS</b>

**IF CHANNEL 10 (FUNCTIONS) = CUSTOM WHITE RECALL (Dmx range value 0 - 79)**

<b>156-205</b>	<b>180</b>	<b>Custom White Recall</b>
<b>206-255</b>	<b>225</b>	<b>White CTC (Channel 8 CTC enabled 43 color temp. Correction Macros: 2000°K-7200°K)</b>

**IF CHANNEL 10 (FUNCTIONS) = CUSTOM WHITE CREATE (Dmx range value 80 - 160)**

<b>156-205</b>	<b>180</b>	<b>Custom White Create (RGB levels selectable by DMX)</b>
<b>206-255</b>	<b>225</b>	<b>White CTC (Channel 8 CTC enabled 43 color temp. Correction Macros: 2000°K-7200°K)</b>

DMX CHANNEL	<b>8</b>	Parameter: <b>CTC (Color temperature correction)</b>
-------------	----------	--

DMX range Value	Mid point DMX value	Move range (degrees)	Mode	Option	Function
-----------------	---------------------	----------------------	------	--------	----------

**IF CHANNEL 7 (White) = WHITE CTC (Dmx range value 206 - 255)**

<b>0-255</b>	<b>43 color temp. Correction Macros: 0 = 2000°K / 128 = 5500°K / 255 = 7200°K</b>				
--------------	---	--	--	--	--

**IF CHANNEL 7 (White) = NO FUNCTION (Dmx range value 0 - 43)**

<b>0-255</b>	<b>Smooth RGB linear Hue correction</b>				
--------------	---	--	--	--	--

DMX CHANNEL	<b>9</b>	Parameter: <b>MACRO</b>
-------------	----------	-------------------------

DMX range Value	Mid point DMX value	Move range (degrees)	Mode	Option	Function
<b>0-14</b>					<b>No Function</b>
<b>15-29</b>					<b>Macro 1</b>
<b>30-44</b>					<b>Macro 2</b>
<b>45-59</b>					<b>Macro 3</b>
<b>60-74</b>					<b>Macro 4</b>
<b>75-89</b>					<b>Macro 5</b>
<b>90-104</b>					<b>Macro 6</b>
<b>105-119</b>					<b>Macro 7</b>
<b>120-134</b>					<b>Macro 8</b>
<b>135-149</b>					<b>Macro 9</b>
<b>150-164</b>					<b>Macro 10</b>
<b>165-179</b>					<b>Macro 11</b>
<b>180-194</b>					<b>Macro 12</b>
<b>195-209</b>					<b>Macro 13</b>
<b>210-225</b>					<b>Macro 14</b>
<b>226-239</b>					<b>Macro 15</b>
<b>240-255</b>					<b>Macro 16</b>

DMX CHANNEL	<b>10</b>	Parameter: <b>FUNCTIONS (Recall, Create and Store the Custom white)</b>
-------------	-----------	---

DMX range Value	Mid point DMX value	Move range (degrees)	Mode	Option	Function
<b>0-79</b>		<b>Custom White Recall (Enable CH 7 for Custom white Recall)</b>			
<b>80-160</b>		<b>Custom White Create (Enable CH 7 for Custom white Creation)</b>			
<b>161-255</b>		<b>Custom White Store (Store the Custom White created )</b>			

WIRING DIAGRAMS

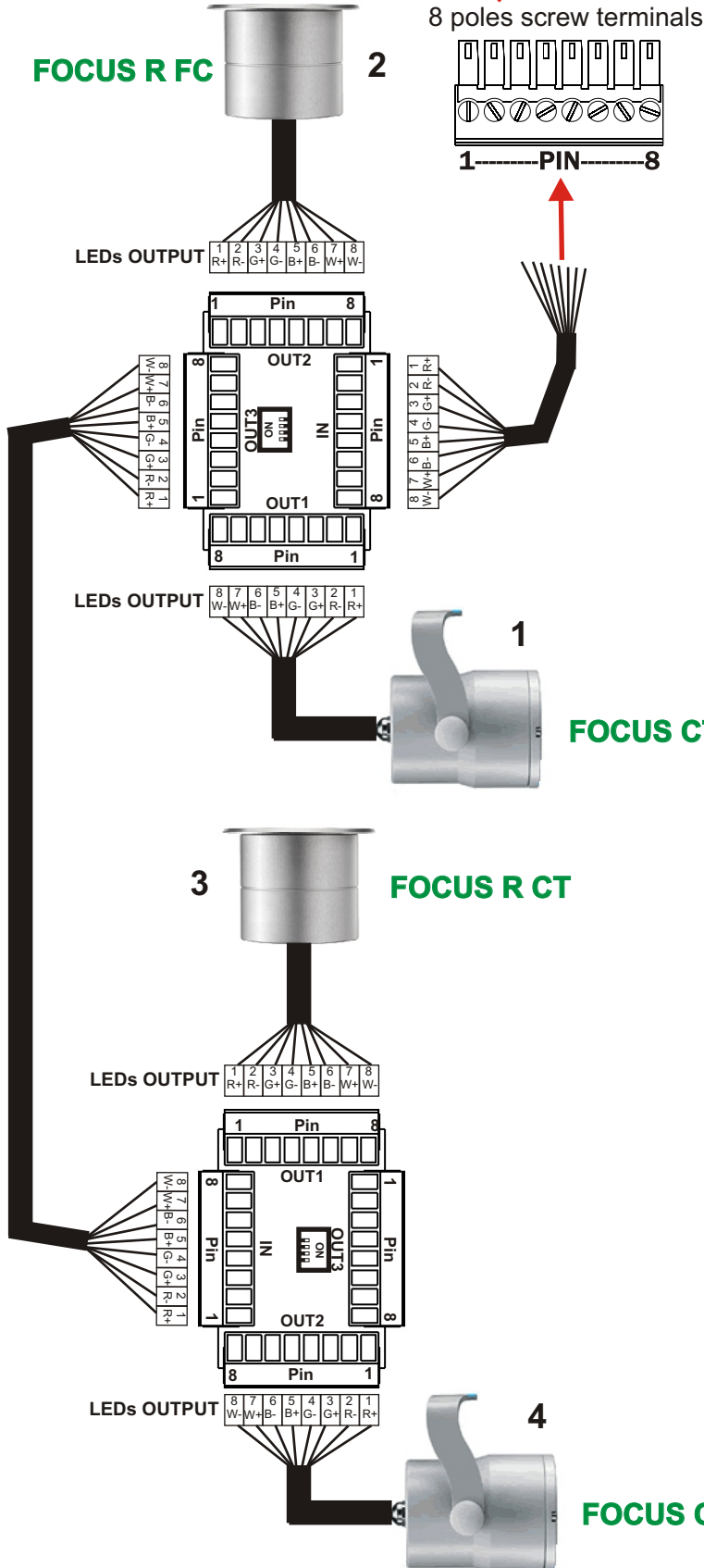
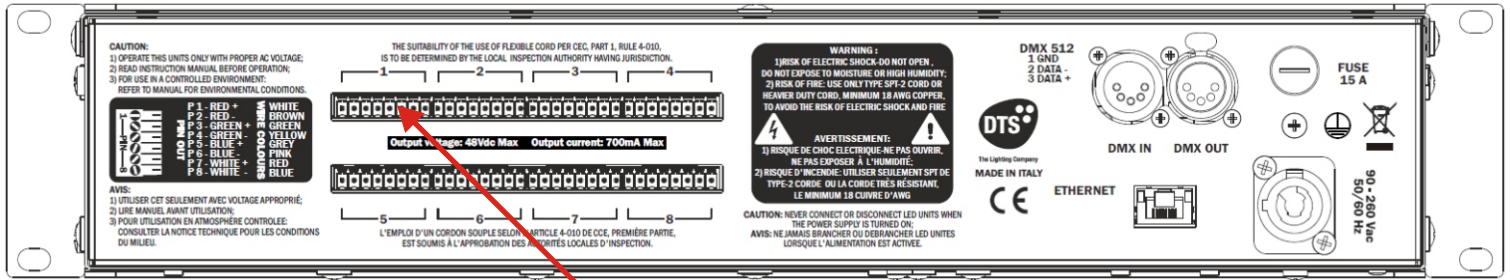

CONNECTION		
PIN OUT	LED	WIRES COLOURS
PIN 1	RED +	WHITE
PIN 2	RED -	BROWN
PIN 3	GREEN +	GREEN
PIN 4	GREEN -	YELLOW
PIN 5	BLUE +	GREY
PIN 6	BLUE -	PINK
PIN 7	WHITE +	RED
PIN 8	WHITE -	BLUE

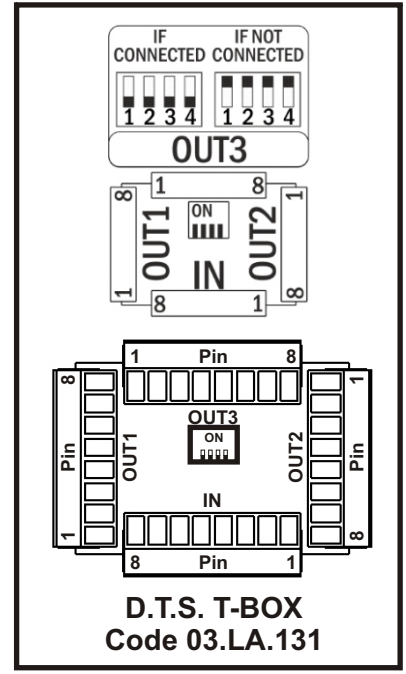

**IMPORTANT:**

The maximum number of FOCUS FC or CT model connectable to each output of the DRIVENET 832 is 4 pcs.

Never plug the cable coming from the Power supply into OUT 1, OUT 2 or OUT 3 of the T-BOX because a wrong connection can seriously damage the projector or the power supply.

Never plug in a new FOCUS projector when the power supply is turned on.

The maximum distance between DRIVENET 832 and the last driven unit should not exceed 50 meters.





**WIRING DIAGRAMS**

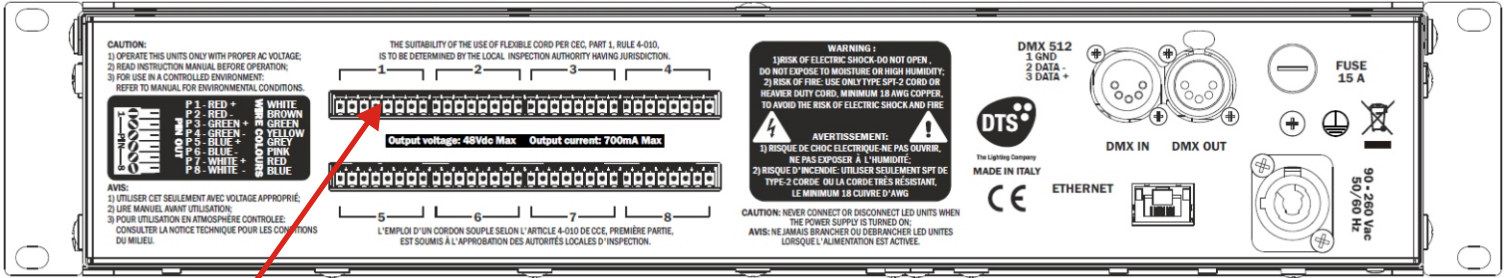

8 poles screw terminals

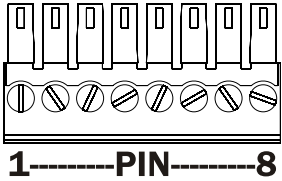

LEDs OUTPUT 1

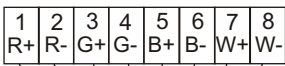

CONNECTION		
PIN OUT	LED	WIRES COLOURS
PIN 1	RED +	WHITE
PIN 2	RED -	BROWN
PIN 3	GREEN +	GREEN
PIN 4	GREEN -	YELLOW
PIN 5	BLUE +	GREY
PIN 6	BLUE -	PINK
PIN 7	WHITE +	RED
PIN 8	WHITE -	BLUE

TITAN HEAD FC



8 poles to M12 female cable converter



CONNECTION		
PIN OUT	LED	WIRES COLOURS
PIN 1	RED +	WHITE
PIN 2	RED -	BROWN
PIN 3	GREEN +	GREEN
PIN 4	GREEN -	YELLOW
PIN 5	BLUE +	GREY
PIN 6	BLUE -	PINK
PIN 7	WHITE -	BLUE
PIN 8	WHITE +	RED

The maximum number of TITAN HEAD, RA7 HEAD, HELIOS or HORUS unit FC, CT or RGBW 48 version connectable to each output of the DRIVENET 832 is 1 piece.

**NEVER CONNECT OR DISCONNECT THE UNIT WHEN THE POWER SUPPLY IS TURNED ON.**

The maximum distance between DRIVENET 832 and unit should not exceed 50 m (FC or CT versions).

The maximum distance between DRIVENET 832 and unit should not exceed 100 m (RGBW 48 version).

**WIRING DIAGRAMS**

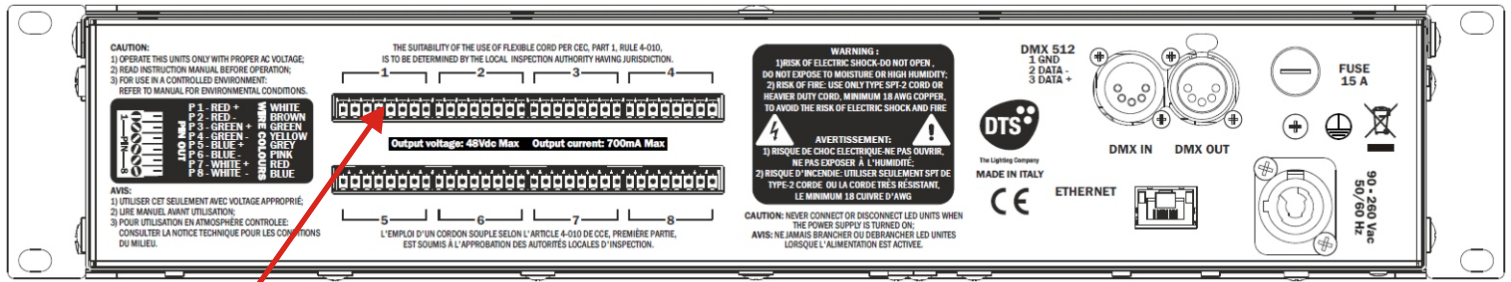

8 poles screw terminals

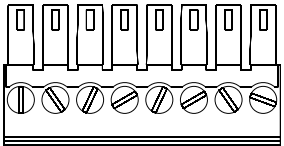

1-----PIN-----8

LEDs OUTPUT 1

1	2	3	4	5	6	7	8
R+	R-	G+	G-	B+	B-	W+	W-

CONNECTION		
PIN OUT	LED	WIRES COLOURS
PIN 1	RED +	WHITE
PIN 2	RED -	BROWN
PIN 3	GREEN +	GREEN
PIN 4	GREEN -	YELLOW
PIN 5	BLUE +	GREY
PIN 6	BLUE -	PINK
PIN 7	WHITE +	RED
PIN 8	WHITE -	BLUE

8 poles to M12 female cable converter

M12 Female Connector

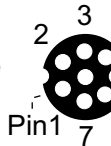

M12 Male Connector

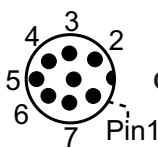

FOS 100 FC

CONNECTION		
PIN OUT	LED	WIRES COLOURS
PIN 1	RED +	WHITE
PIN 2	RED -	BROWN
PIN 3	GREEN +	GREEN
PIN 4	GREEN -	YELLOW
PIN 5	BLUE +	GREY
PIN 6	BLUE -	PINK
PIN 7	WHITE -	BLUE
PIN 8	WHITE +	RED

The maximum number of FOS 100 FC or CT unit connectable to each output of the DRIVENET 832 is 1 piece.

The maximum number of FOS 66 END FC or CT unit connectable to each output of the DRIVENET 832 is 1 piece.

The maximum number of FOS 33 FC or CT unit connectable to each output of the DRIVENET 832 is 3 pcs (2 x FOS 33 IN/OUT + 1 x FOS 33 END).

**NEVER CONNECT OR DISCONNECT THE UNIT WHEN THE POWER SUPPLY IS TURNED ON.**

**The maximum distance between DRIVENET 832 and FOS unit should not exceed 50 meters.**

**WIRING DIAGRAMS**

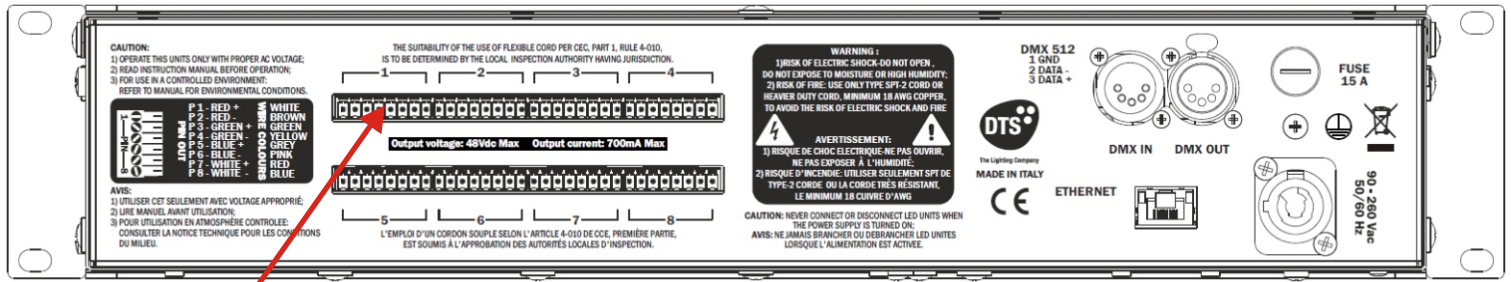

8 poles screw terminals

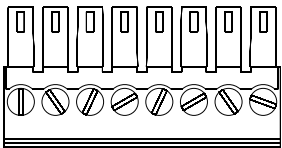

1-----PIN-----8

LEDs OUTPUT 1

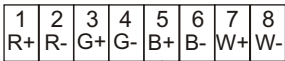

CONNECTION		
PIN OUT	LED	WIRES COLOURS
PIN 1	RED +	WHITE
PIN 2	RED -	BROWN
PIN 3	GREEN +	GREEN
PIN 4	GREEN -	YELLOW
PIN 5	BLUE +	GREY
PIN 6	BLUE -	PINK
PIN 7	WHITE +	RED
PIN 8	WHITE -	BLUE

8 poles to M12 female cable converter

M12 Female Connector

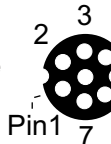

M12 Male Connector

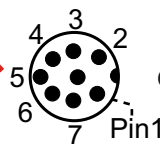

FREELINE 90 FC

CONNECTION		
PIN OUT	LED	WIRES COLOURS
PIN 1	RED +	WHITE
PIN 2	RED -	BROWN
PIN 3	GREEN +	GREEN
PIN 4	GREEN -	YELLOW
PIN 5	BLUE +	GREY
PIN 6	BLUE -	PINK
PIN 7	WHITE -	BLUE
PIN 8	WHITE +	RED

The maximum number of FREELINE 90, 60 or 30 FC unit connectable to each output of the DRIVENET 832 is 1 piece.

**NEVER CONNECT OR DISCONNECT THE UNIT WHEN THE POWER SUPPLY IS TURNED ON.**

The maximum distance between DRIVENET 832 and FREELINE unit should not exceed 50 meters.

PROUDLY  
MADE IN ITALY



DTS products are designed  
and manufactured at the  
DTS plants in Italy



**ISO 9001:2008**

DTS quality system is certified  
to the ISO 9001:2008 standard

**D.T.S. Illuminazione s.r.l** - Via Fagnano Selve 12-14  
47843 Misano Adriatico (RN) Italy  
Tel.: +39 0541 611131 Fax +39 0541 611111  
Info@dts-lighting.it www.dts-lighting.it



05171257